

TOUGHMesh

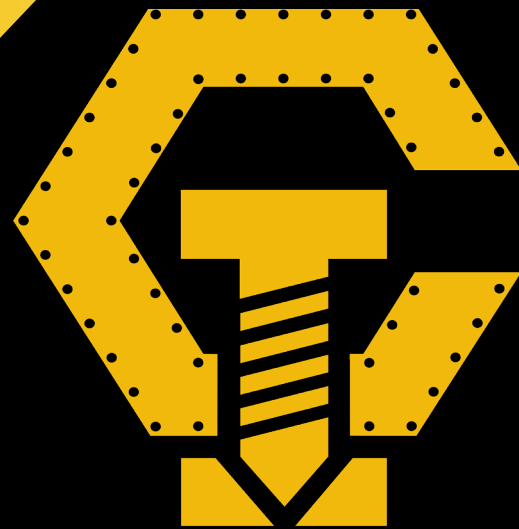

CT INNOVATIONS

Do Better. Be Better.

Our DNA

With over 125 years of combined electrical and mechanical support systems experience, the CT Innovations leadership team set out to build an agile company that is focused on, and dedicated to, customers, not shareholders. In our view, great service is not a luxury; it is a necessity that too few deliver.

At CT Innovations, we focus on one thing and one thing only our customers' needs. We believe in taking action, being easy to do business with, and being held accountable by those we serve. We are not all things to all people. We will, however, always strive to be our customers' preferred supplier in our space and to be recognized as an organization that consistently provides superior value, service, and innovation.

Company Creed:

“Do Better. Be Better.”



A photograph of an industrial refinery or chemical plant. On the left, a tall distillation column with alternating red and white sections stands against a blue sky with light clouds. The rest of the image is filled with a complex network of blue steel structures, yellow safety railings, and numerous silver pipes and tanks. The overall scene is one of a large-scale industrial operation.

“Always Do Your Best
& Make Your Mark”

- PK





TOUGHMesh:

Differentiate

Wirebasket re-imagined: with decades of commercial and industrial basket experience, CT Innovations compiled the major shortcomings of the product range and developed a full line of solutions to drive usable innovation resulting in actual project savings. Often viewed as a commodity, CT Innovations put forth the effort to give designers and installers critical stand alone benefits and solutions not seen in the commercial segment.



TIM

Key Benefits

- Reduce Supports & Anchors
- Reduce Labor & Inconsistencies
- Save Time With Tool-less Accessories
- Maximum Site Adaptability
- Reduce Field Cutting & Maximize Safety
- Superior Finish Options

Do Better.



Safety

Reduce sharp edges with CTT's patented Safe-T-Curl edge & Crimped-2-Go fittings. Stop snagging wrists and wires and start protecting what matters most.

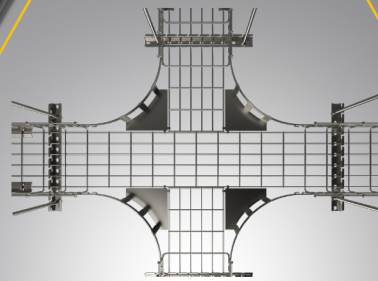

Performance

A stronger profile equates to more loading capabilities & longer support spans; drastically simplifying your installation.

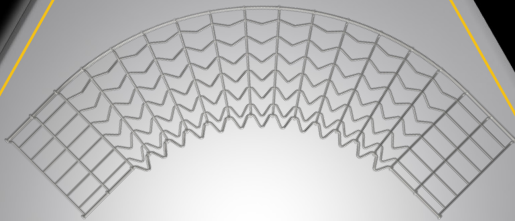

Value

Keep schedules and reduce budgets by removing installation bottle necks with innovative product, and engineered solutions.

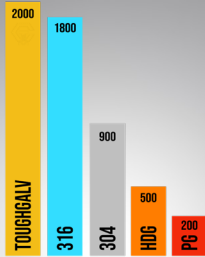

Protection

TOUGHGalv represents an industry first finish robust enough to tackle offshore rigs, yet refined and economical enough for data centers.



Availability

Let's make customer service great again. With 3 different assembly plants and a growing distribution list, CTI is committed to having product ready when you need it.

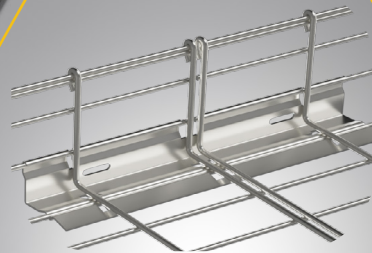

Productivity

Eliminate heavy field modifications and labor intensive connections with CTI's toolless POSI-LOK splice plate and C2G fittings.

Be Better.

Picture Index

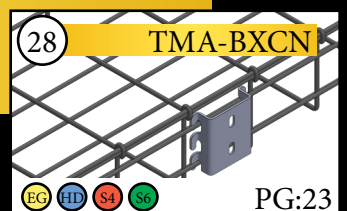
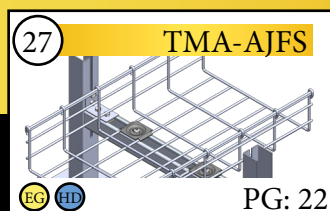
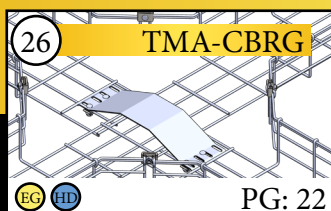
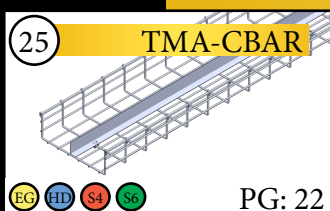
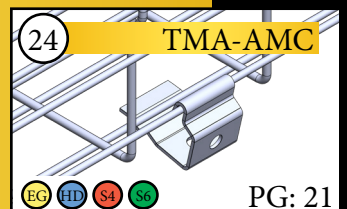
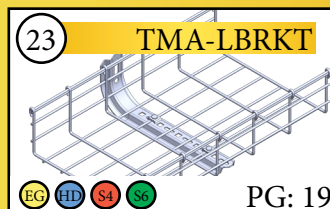
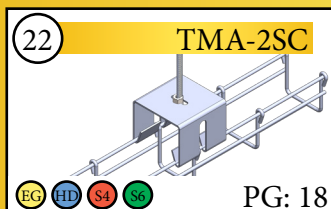
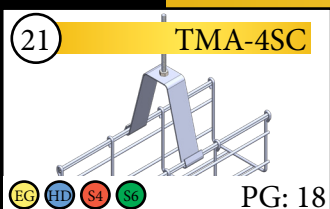
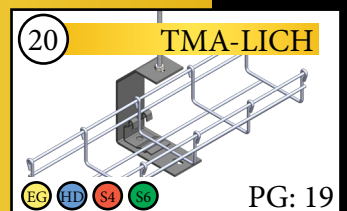
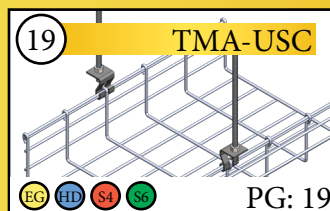
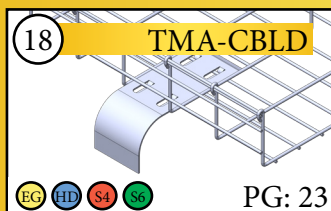
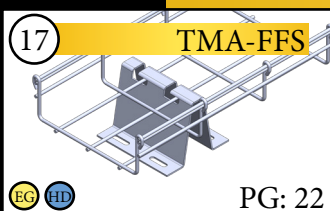
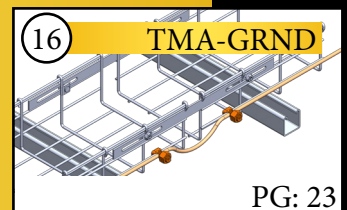
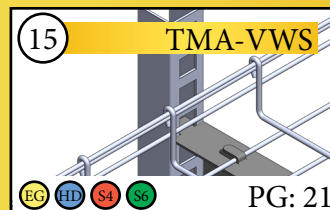
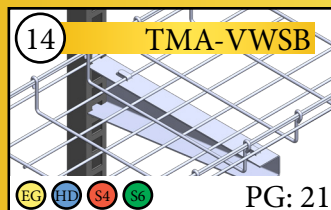
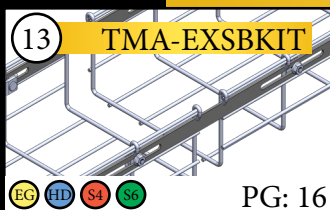
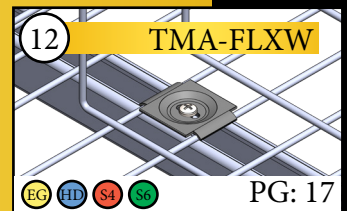
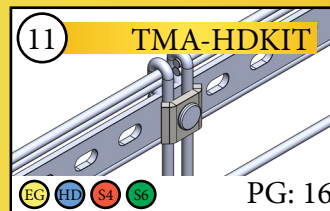
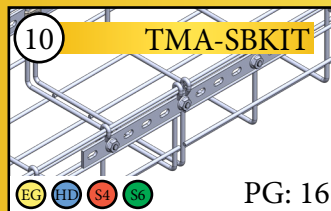
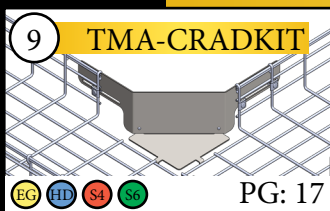
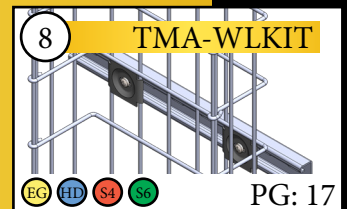
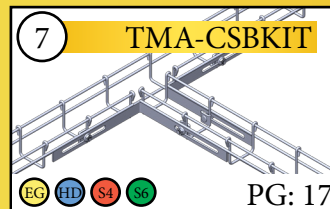
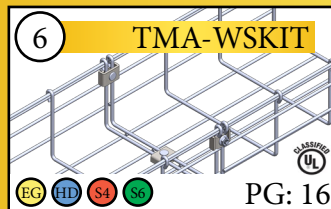
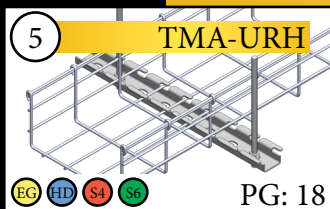
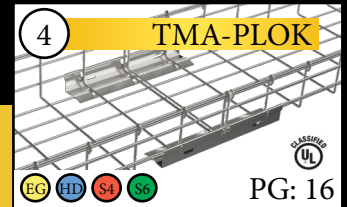
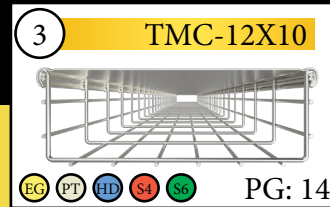
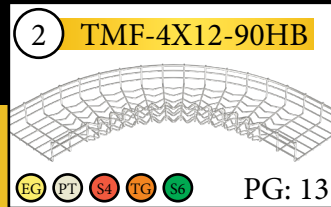
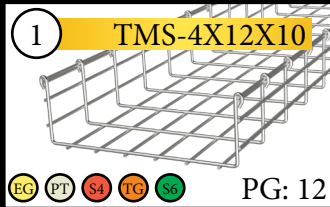

Application Reference

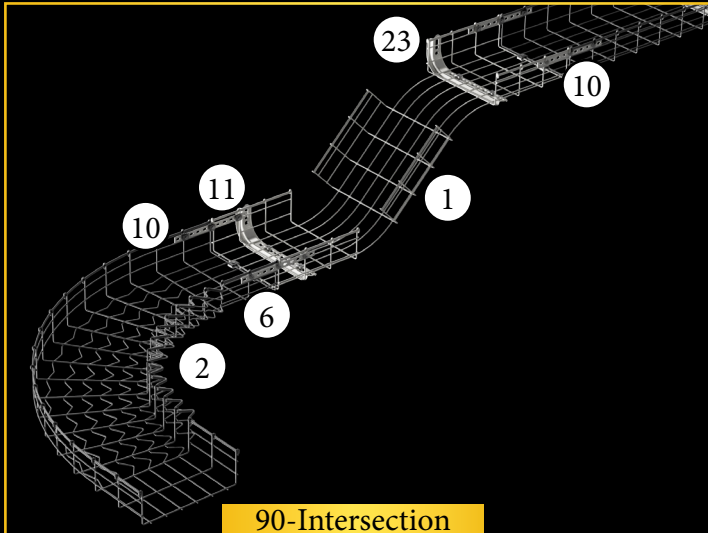

90-Intersection

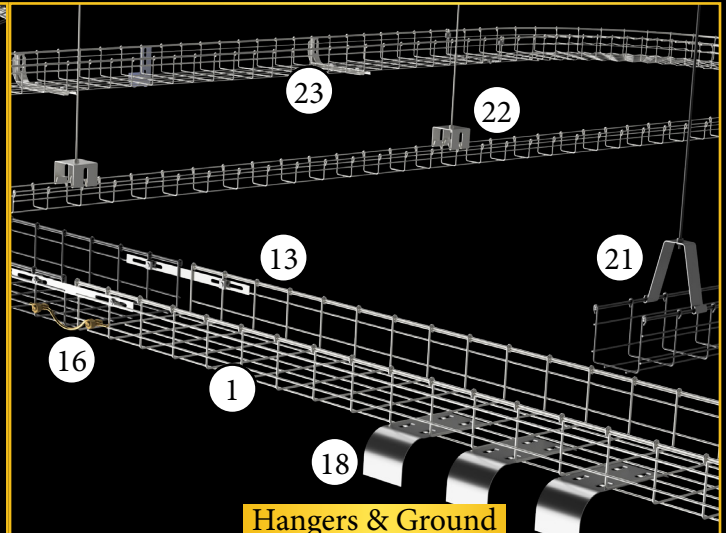

Hangers & Ground

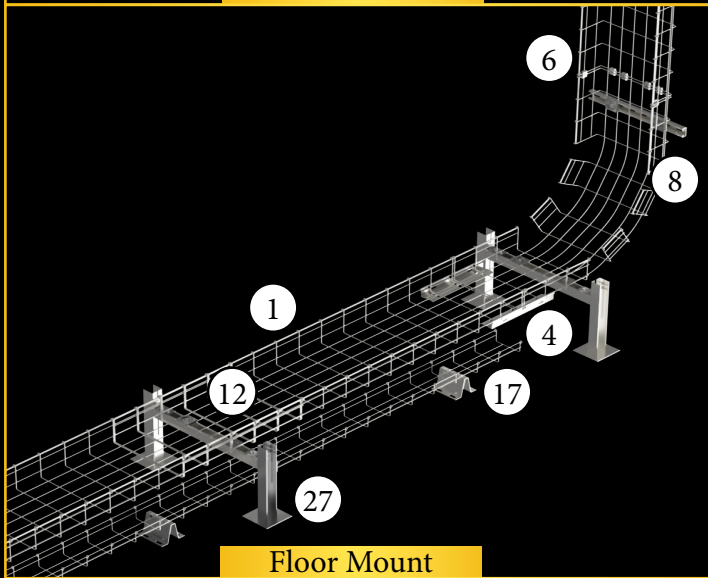

Floor Mount

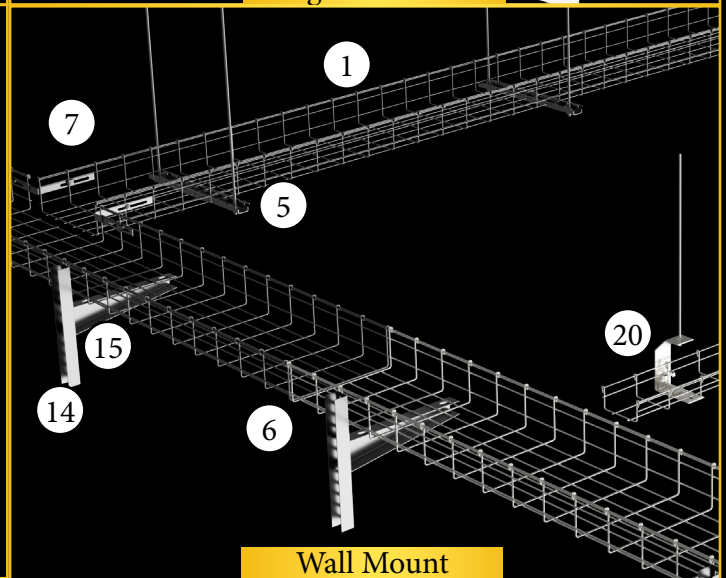

Wall Mount

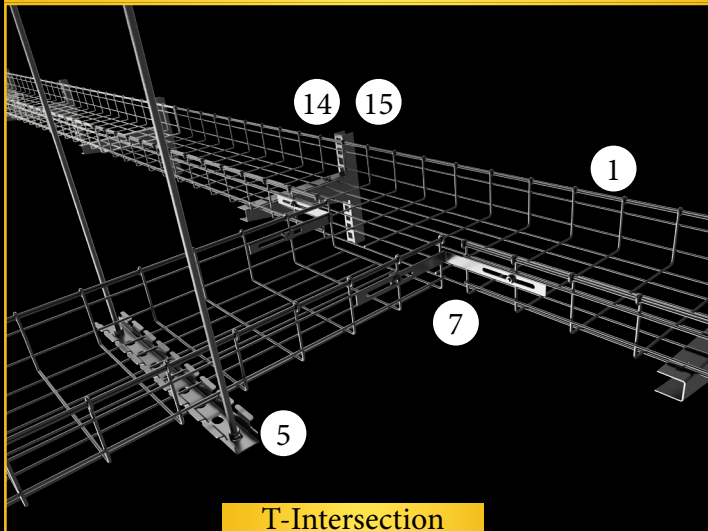

T-Intersection

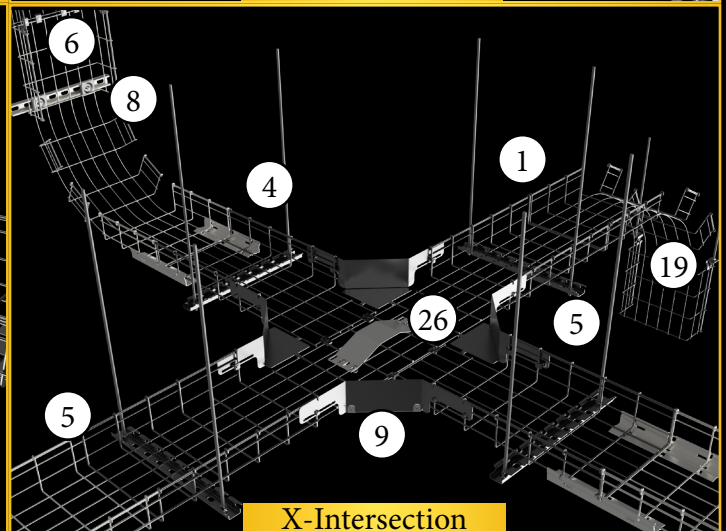

X-Intersection

TOUGHMesh Properties

Grounding Information:

This product is classified by Underwriters Laboratories, Inc. as an equipment grounding conductor only. Grounding eligibility is determined by cross-sectional area, material properties, and splicing methodology; therefore smaller sizes may not apply, please reference chart on next page.

Finish Information:

- EG Electroplated zinc galvanized finish applied after fabrication
 Recommended Application: Indoor
 ASTM B633
- PT Painted finish applied after fabrication
 Recommended Application: Indoor
 ASTM: N/A
- HD Hot Dip Galvanized finish applied after fabrication
 Recommended Application: Indoor / outdoor / industrial
 ASTM: A123
- S4 Stainless steel 304 finish applied before fabrication
 Recommended Application: Indoor / outdoor / industrial / offshore
 ASTM: A580/A580M
- TG TOUGHGalv finish applied before fabrication
 Recommended Application: Indoor / outdoor / industrial / offshore
 ASTM B997
- S6 Stainless steel 316 finish applied before fabrication
 Recommended Application: Indoor / outdoor / industrial / offshore
 ASTM: A580/A580M



Protection Information:

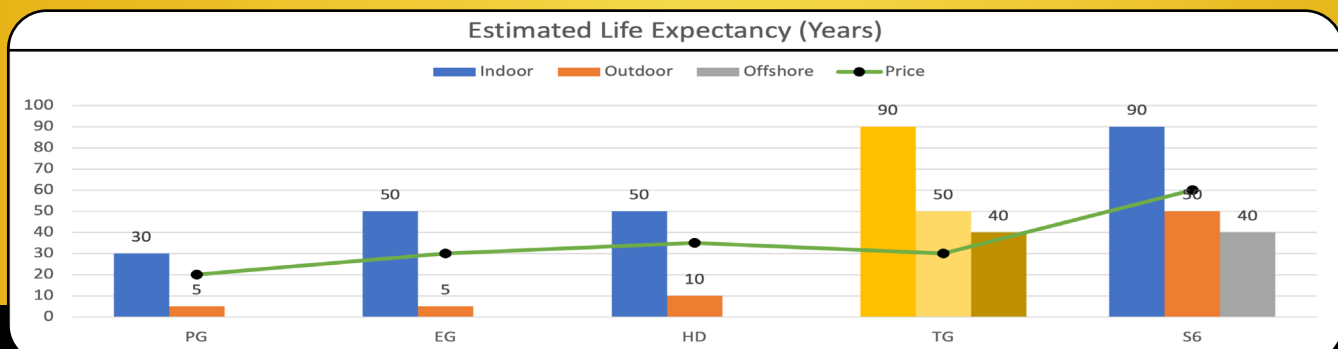

Finish Recommendation

EG

ElectroGalvanized

PT

Painted

HD

HotDipGalvanized

S4

304 Stainless

TG

TOUGHGalv

S6

316 Stainless



Indoor



Outdoor



Solar



Industrial



Offshore



Food & Bev

EG



PT



HD



S4



TG



S6



Straight Sections



 ElectroGalvanized	 Painted	 HotDipGalvanized	 304 Stainless	 TOUGHGalv	 316 Stainless
 Height: 2" h Inside Height: 2.1in H Outside Height: 2.5in	 Height: 4" h Inside Height: 4.1in H Outside Height: 4.5in	 Height: 6" h Inside Height: 6.0in H Outside Height: 6.2in			

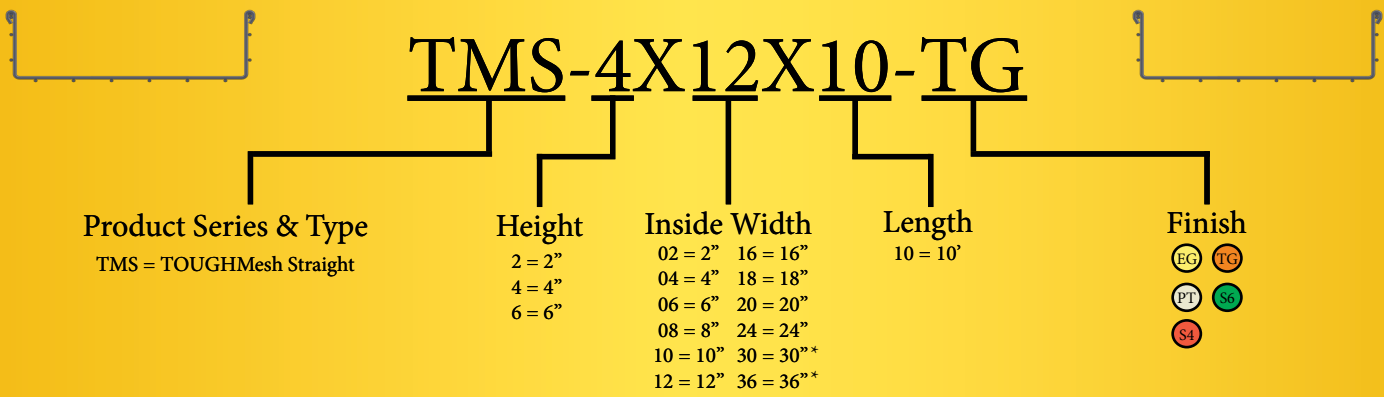

*Please contact CTI for special requests

Basket Size H X W	Load (lbs/ft) 5ft	Load (lbs/ft) 10ft	Reccomended Splices			Est. Cable Fill QTY (50% fill)		Nominal Area (in^2) Inside Basket	Physical Weight (lbs) 10ft sections
			Washer Splice Kits	Posi-Lok Mini	Posi-Lok	CAT 6 (.25in)	CAT 6A (.28in)		
2X2	15	11	2			40	32	4	4.5
2X4	18	18	2	2		81	64	8	6.7
2X6	24	14	2	2		122	97	12	7.5
2X8	31	13	3	2		163	129	16	8.7
2X10	46	18	3	2		203	162	20	10.6
2X12	55	17	3		2	244	194	24	12.8
2X16	117	31	4		2	326	259	32	19.3
2X18	117	33	4		2	366	292	36	19.7
2X20	123	36	4		2	407	324	40	24.8
2X24	132	37	4		2	489	389	48	27.8
4X4	62	15	4	2		163	129	16	8.7
4X6	66	18	4	2		244	194	24	10.5
4X8	78	18	5	2		326	259	32	12.8
4X10	78	18	5	2		407	324	40	18.4
4X12	108	30	6		2	489	389	48	19.3
4X16	123	36	6		2	652	519	64	24.8
4X18	127	37	6		2	733	584	72	25.7
4X20	137	38	7		2	815	649	80	27.8
4X24	145	40	7		2	978	779	96	28.4
6X8	62	29	6	2		489	389	48	19.3
6X10	62	36	6	2		611	487	60	23.8
6X12	117	36	7		2	733	584	72	24.8
6X16	133	38	7		2	978	779	96	27.8
6X18	144	37	7		2	1100	877	108	29.3
6X20	146	36	8		2	1222	974	120	30.9
6X24	148	37	8		2	1467	1169	144	35.2

C2G Fittings

EG

ElectroGalvanized

PT

Painted

HD

HotDipGalvanized

S4

304 Stainless

TG

TOUGHGalv

S6

316 Stainless

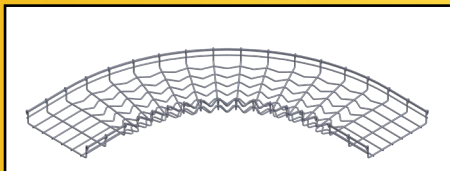

Height: 2"

h Inside Height: 2.1in H Outside Height: 2.5in

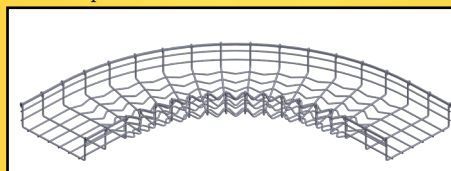

Height: 4"

h Inside Height: 4.1in H Outside Height: 4.5in

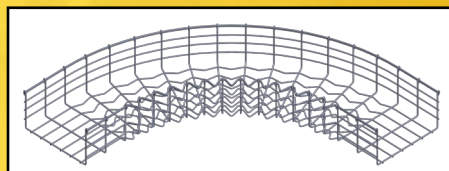

Height: 6"

h Inside Height: 6.0in H Outside Height: 6.2in

TMF-4X12-90HB-TG

Product Series & Type
TMF = TOUGHMesh Fitting

Height

2 = 2"
4 = 4"
6 = 6"

Inside Width

02 = 2" 12 = 12"
04 = 4" 16 = 16"
06 = 6" 18 = 18"
08 = 8" 20 = 20"
10 = 10"

Angle

45 = 45°
90 = 90°

Style

HB = Horz Bend

Finish



*Please contact CTI for special requests

90 HB Fabrication Time

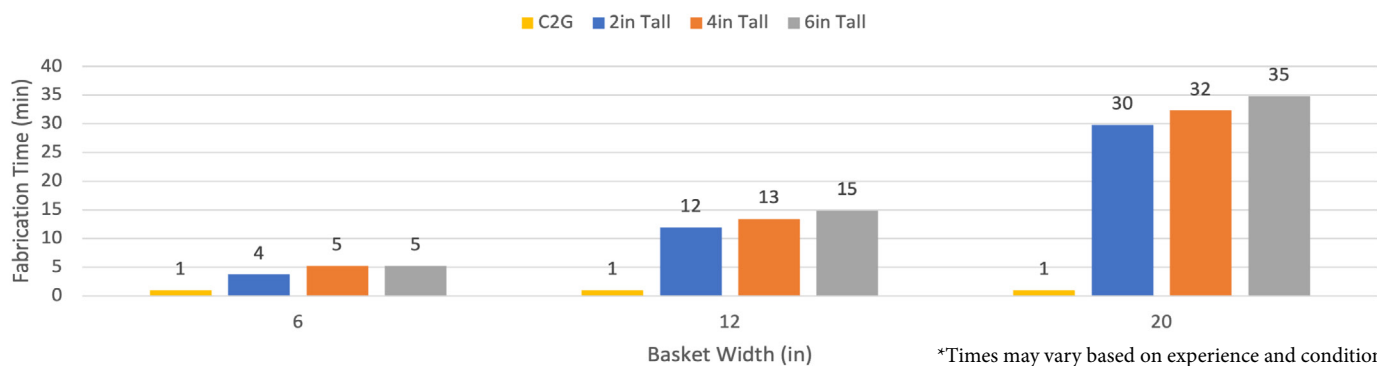

Field Fabrication Safety

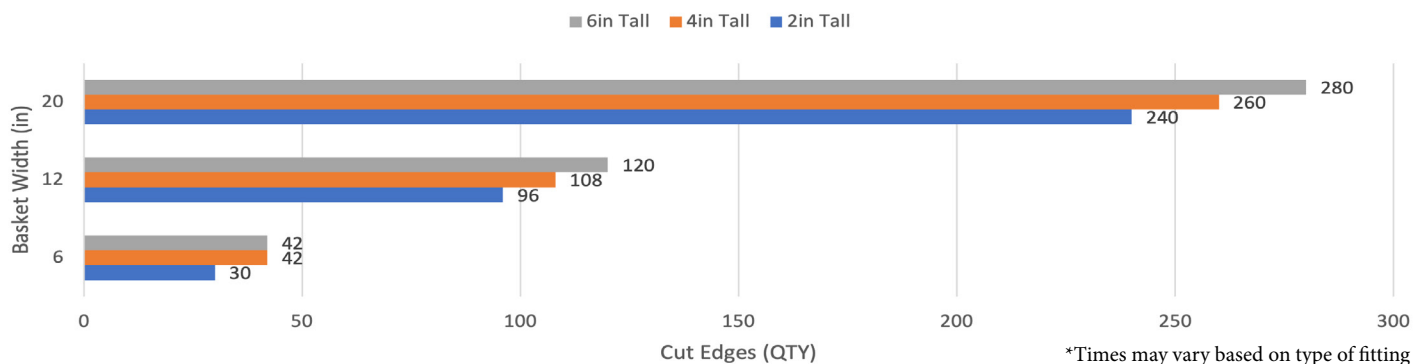

Snap-On Covers



ElectroGalvanized



Painted



HotDipGalvanized



304 Stainless



TOUGHGalv



316 Stainless



Snap-On Covers

Covers do not require any additional accessories for its installation, it is placed under pressure on the upper curls of the tray.

Width (in)

2	8	16
4	10	20
6	12	24

TMC-12X10-EG

Product Series & Type

TMC = TOUGHMesh Cover

Inside Width

02 = 2" 12 = 12"
 04 = 4" 16 = 16"
 06 = 6" 18 = 18"
 08 = 8" 20 = 20"
 10 = 10" 24 = 24"

Length

10 = 10'

Finish



*Please contact CTI for special requests

**Not recommended for high impact

Cover Installation Comparison

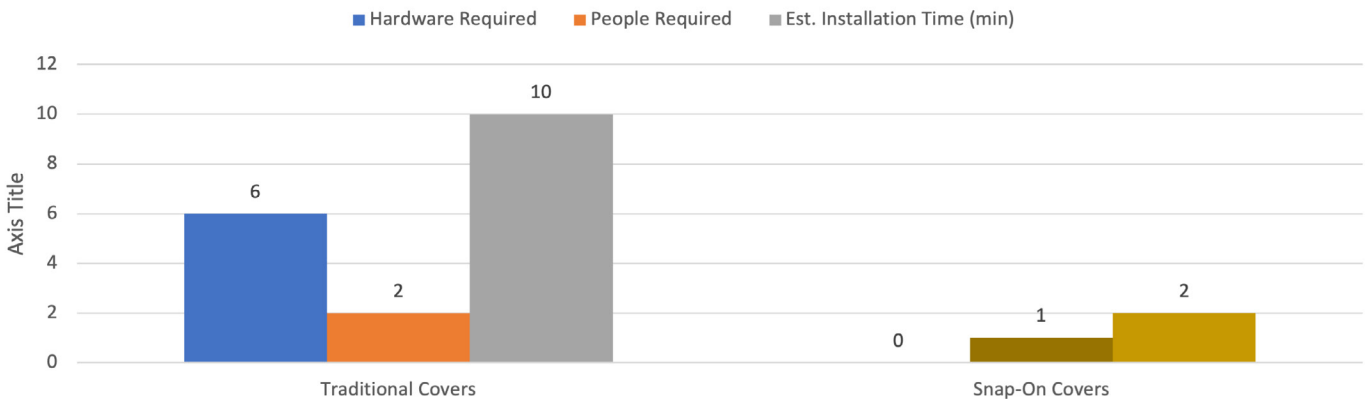

*Times may vary based on experience and conditions

Accessories



Finish Reference



ElectroGalvanized



Painted



HotDipGalvanized



304 Stainless





TOUGHGalv

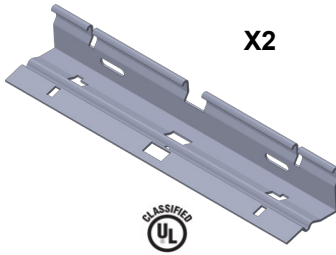

316 Stainless

Accessory Overview

Catalog # →	TMA-PLOK		Description ←
Unit of Sale →	"Posi-Lok" Splice		
Category →	Sold in Pairs		QTY of Image ←
TOUGHMesh Compatibility {	Type: Splicing	 X2	Product Image ←
Piece Count →	TM Width: 12"-36"		Certifications ←
	Hardware: Toolless		
	Includes: 2 pieces		} SKU # by Finish
	TMA-PLOK-EG	TMA-PLOK-S4	
	TMA-PLOK-HD	TMA-PLOK-S6	

Accessory "Type"

Splicing



Supports

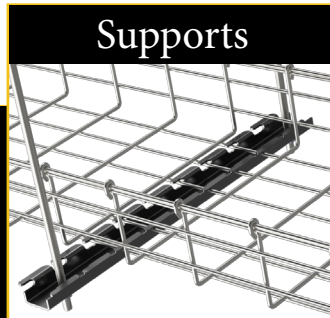

Clamps & Guides



Grounding

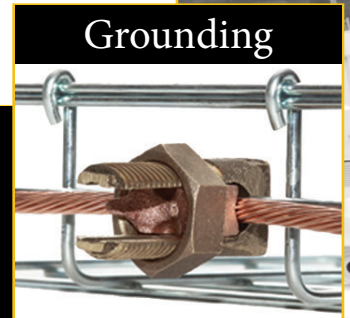

Drop Outs



Barriers

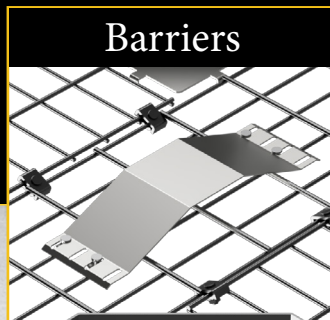

Adapters

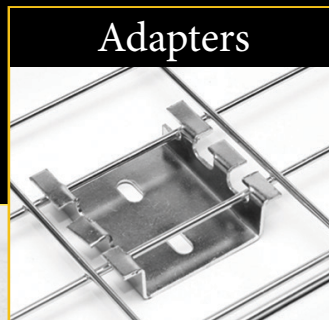

J-Hooks

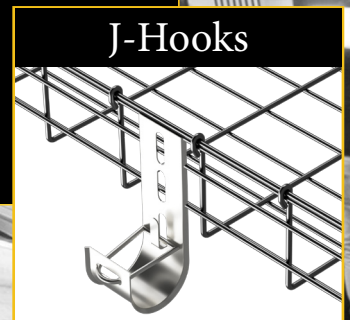

Splices & Kits



ElectroGalvanized



Painted



HotDipGalvanized



304 Stainless



TOUGHGalv



316 Stainless

TMA-PLOK

"Posi-Lok" Splice

Sold in Pairs

Type: Splicing
TM Height: 2", 4", 6"
TM Width: 12"-36"
Hardware: Toolless
Includes: 2 pieces

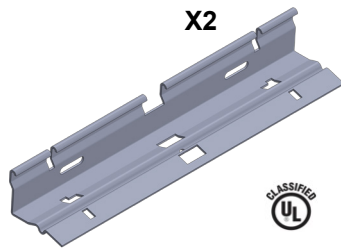

X2



TMA-PLOK-EG

TMA-PLOK-S4

TMA-PLOK-HD

TMA-PLOK-S6

TMA-PLOKM

"Posi-Lok Mini" Splice

Sold in Pairs

Type: Splicing
TM Height: 2", 4", 6"
TM Width: 4"-10"
Hardware: Toolless
Includes: 2 pieces

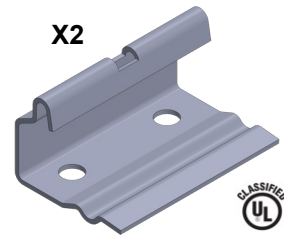

X2



TMA-PLOKM-EG

TMA-PLOKM-S4

TMA-PLOKM-HD

TMA-PLOKM-S6

TMA-WSKIT

Washer Splice Kits

Sold in Bags of 50 KITS

Type: Splicing
TM Height: 2", 4", 6"
TM Width: 2"-36"
Hardware: 6mm
Includes: 4 pieces (1 KIT)



X50



TMA-WSKIT-EG

TMA-WSKIT-S4

TMA-WSKIT-HD

TMA-WSKIT-S6

TMA-HDKIT

Hold Down Kits

Sold in Bags of 50 KITS

Type: Splicing
TM Height: 2", 4", 6"
TM Width: 2"-36"
Hardware: 6mm
Includes: 3 pieces (1 KIT)



X50



TMA-HDKIT-EG

TMA-HDKIT-S4

TMA-HDKIT-HD

TMA-HDKIT-S6

TMA-SBKIT

Splice Bar Kits

Sold as KIT

Type: Splicing
TM Height: 2", 4", 6"
TM Width: 2"-36"
Hardware: HDKIT
Includes: 26 pieces (1 KIT)

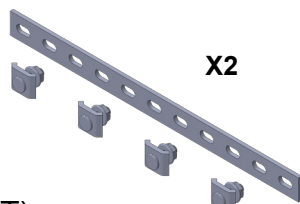

X2

TMA-SBKIT-EG

TMA-SBKIT-S4

TMA-SBKIT-HD

TMA-SBKIT-S6

TMA-EXSBKIT

Expansion Splice Bar Kit

Sold as KIT

Type: Splicing
TM Height: 2", 4", 6"
TM Width: 2"-36"
Hardware: HDKIT
Includes: 14 pieces (1 KIT)

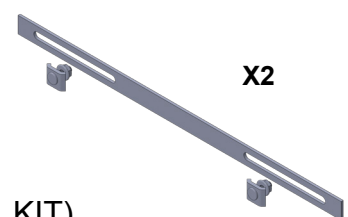

X2

TMA-EXSBKIT-EG

TMA-EXSBKIT-S4

TMA-EXSBKIT-HD

TMA-EXSBKIT-S6

Splices & Kits



ElectroGalvanized



Painted



HotDipGalvanized



304 Stainless



TOUGHGalv



316 Stainless

TMA-CRADKIT

Corner Radius Kits

Sold as KIT

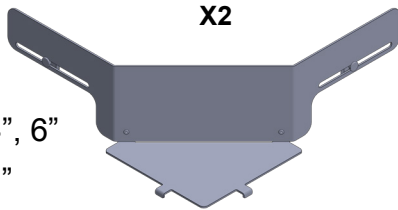

Type: Splicing

TM Height: 2", 4", 6"

TM Width: 2"-36"

Hardware: HDKIT

Includes: 26 pieces (1 KIT)

2"
Tall

TMA-CRADKIT-2-EG

TMA-CRADKIT-2-S4

N/A

TMA-CRADKIT-2-S6

4"
Tall

TMA-CRADKIT-4-EG

TMA-CRADKIT-4-S4

N/A

TMA-CRADKIT-4-S6

6"
Tall

TMA-CRADKIT-6-EG

TMA-CRADKIT-6-S4

N/A

TMA-CRADKIT-6-S6

TMA-CSBKIT

Corner Splice Bar Kit

Sold as KIT

Type: Splicing

TM Height: 2", 4", 6"

TM Width: 2"-36"

Hardware: HDKIT

Includes: 14 pieces (1 KIT)

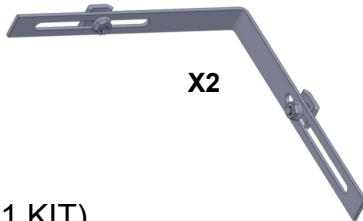

TMA-CSBKIT-EG

TMA-CSBKIT-S4

N/A

TMA-CSBKIT-S6

TMA-WLKIT

Wall Kit

Sold as KIT

Type: Clamp & Guide

TM Height: 2", 4", 6"

TM Width: 2"-36"

Hardware: 6mm

Includes: 6 pieces (1 KIT)

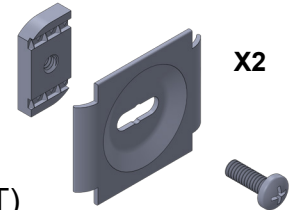

TMA-WLKIT-EG

TMA-WLKIT-S4

TMA-WLKIT-HD

TMA-WLKIT-S6

TMA-STSB

Standard Splice Bar

Sold Individually

Type: Splicing

TM Height: 2", 4", 6"

TM Width: 2"-36"

Hardware: HDKIT (not incl.)

Includes: 1 piece

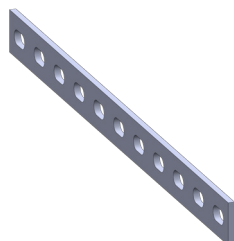

TMA-STSB-EG

TMA-STSB-S4

TMA-STSB-HD

TMA-STSB-S6

TMA-FLXW

Flat Cross Washer

Sold in Bags of 20

Type: Splicing

TM Height: 2", 4", 6"

TM Width: 2"-36"

Hardware: 6mm (not Incl.)

Includes: 20 pieces

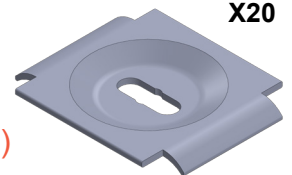

TMA-FLXW-EG

TMA-FLXW-S4

TMA-FLXW-HD

TMA-FLXW-S6

Supports & Brackets



ElectroGalvanized



Painted



HotDipGalvanized



304 Stainless



TOUGHGalv



316 Stainless

TMA-URH

Universal Rapid Hanger

Sold Individually

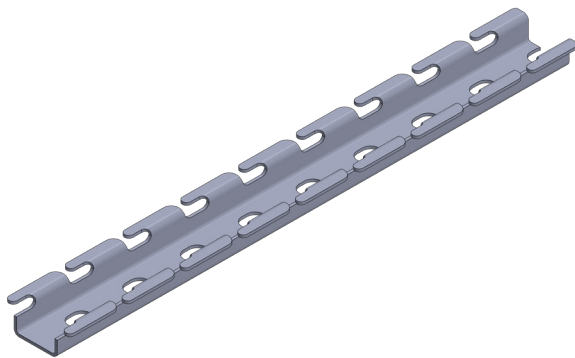

6" Mesh Width	TMA-URH-06-EG	TMA-URH-06-S4
	TMA-URH-06-HD	TMA-URH-06-S6
8" Mesh Width	TMA-URH-08-EG	TMA-URH-08-S4
	TMA-URH-08-HD	TMA-URH-08-S6
10" Mesh Width	TMA-URH-10-EG	TMA-URH-10-S4
	TMA-URH-10-HD	TMA-URH-10-S6
12" Mesh Width	TMA-URH-12-EG	TMA-URH-12-S4
	TMA-URH-12-HD	TMA-URH-12-S6
16" Mesh Width	TMA-URH-16-EG	TMA-URH-16-S4
	TMA-URH-16-HD	TMA-URH-16-S6
18" Mesh Width	TMA-URH-18-EG	TMA-URH-18-S4
	TMA-URH-18-HD	TMA-URH-18-S6
20" Mesh Width	TMA-URH-20-EG	TMA-URH-20-S4
	TMA-URH-20-HD	TMA-URH-20-S6
24" Mesh Width	TMA-URH-24-EG	TMA-URH-24-S4
	TMA-URH-24-HD	TMA-URH-24-S6

Type: Support

TM Height: 2", 4", 6"

TM Width: 2"-24"

ATR: 1/4" or 3/8" (not incl.)

Includes: 1 piece

* Widths > 24" available upon request

TMA-2SC

2" Suspension Clip

Sold in Bags of 10

Type: Support

TM Height: 2"

TM Width: 2"

ATR: 1/4" (not incl.)

Includes: 10 pieces

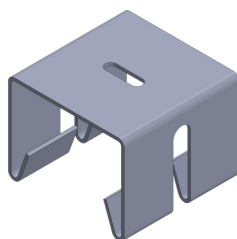

TMA-2SC-EG	TMA-2SC-S4
TMA-2SC-HD	TMA-2SC-S6

TMA-4SC

4" Suspension Clip

Sold in Bags of 10

Type: Support

TM Height: 2", 4"

TM Width: 4"

ATR: 1/4" (not incl.)

Includes: 10 pieces



TMA-4SC-EG	TMA-4SC-S4
TMA-4SC-HD	TMA-4SC-S6

Supports & Brackets



ElectroGalvanized



Painted



HotDipGalvanized



304 Stainless



TOUGHGalv



316 Stainless

TMA-LICH

Lay In Cable Hanger

Sold Individually

Type: Support

TM Height: 2"

Width: 2"-6"

ATR: 1/4" (not incl.)

Includes: 1 piece

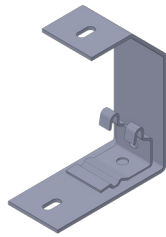

TMA-LICH-EG

TMA-LICH-S4

TMA-LICH-HD

TMA-LICH-S6

TMA-USC

Universal Suspension Clip

Sold in Bags of 10

Type: Support

TM Height: 2", 4", 6"

TM Width: 2"-36"

ATR: 1/4" (not incl.)

Includes: 10 pieces

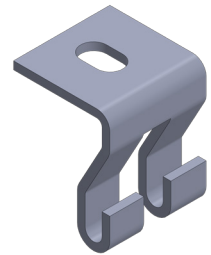

TMA-USC-EG

TMA-USC-S4

TMA-USC-HD

TMA-USC-S6

TMA-LBRKT

L Bracket

Sold in Individually

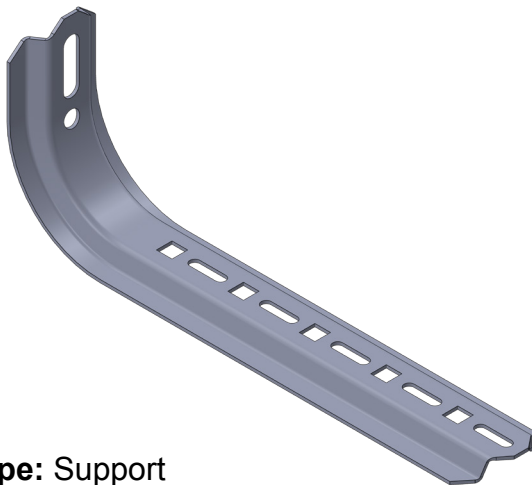

Type: Support

TM Height: 2", 4", 6"

TM Width: 2"-24"

Hardware: HDKIT (not incl.)

Includes: 1 piece

Ref: HDKIT (Pg. 16)

Ref: FLXW (Pg. 17)

* Contact CTI for alternative sizes

6"
Mesh
Width

TMA-LBRKT-06-EG

TMA-LBRKT-06-S4

TMA-LBRKT-06-HD

TMA-LBRKT-06-S6

8"
Mesh
Width

TMA-LBRKT-08-EG

TMA-LBRKT-08-S4

TMA-LBRKT-08-HD

TMA-LBRKT-08-S6

10"
Mesh
Width

TMA-LBRKT-10-EG

TMA-LBRKT-10-S4

TMA-LBRKT-10-HD

TMA-LBRKT-10-S6

12"
Mesh
Width

TMA-LBRKT-12-EG

TMA-LBRKT-12-S4

TMA-LBRKT-12-HD

TMA-LBRKT-12-S6

16"
Mesh
Width

TMA-LBRKT-16-EG

TMA-LBRKT-16-S4

TMA-LBRKT-16-HD

TMA-LBRKT-16-S6

18"
Mesh
Width

TMA-LBRKT-18-EG

TMA-LBRKT-18-S4

TMA-LBRKT-18-HD

TMA-LBRKT-18-S6

20"
Mesh
Width

TMA-LBRKT-20-EG

TMA-LBRKT-20-S4

TMA-LBRKT-20-HD

TMA-LBRKT-20-S6

24"
Mesh
Width

TMA-LBRKT-24-EG

TMA-LBRKT-24-S4

TMA-LBRKT-24-HD

TMA-LBRKT-24-S6

Supports & Brackets



ElectroGalvanized



Painted



HotDipGalvanized



304 Stainless



TOUGHGalv



316 Stainless

TMA-SWB

Strut Wall Bracket

Sold Individually

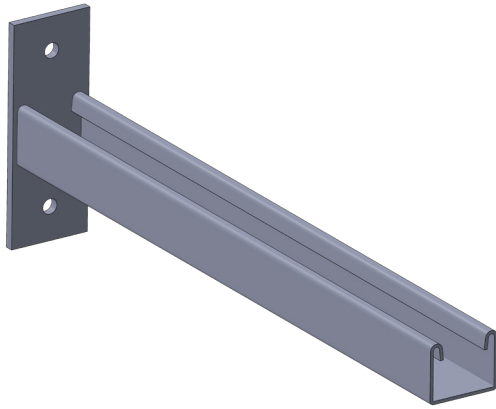

Type: Support
TM Height: 2", 4", 6"
TM Width: 2"-24"
Hardware: WLKIT (not incl.)
Includes: 1 piece
Ref: Wall Kit (Pg. 17)
Ref: Strut Retention Clip (Pg. 20)
 * Contact CTI for alternative sizes

6" Mesh Width	TMA-SWB-06-EG	TMA-SWB-06-S4
	TMA-SWB-06-HD	TMA-SWB-06-S6
8" Mesh Width	TMA-SWB-08-EG	TMA-SWB-08-S4
	TMA-SWB-08-HD	TMA-SWB-08-S6
10" Mesh Width	TMA-SWB-10-EG	TMA-SWB-10-S4
	TMA-SWB-10-HD	TMA-SWB-10-S6
12" Mesh Width	TMA-SWB-12-EG	TMA-SWB-12-S4
	TMA-SWB-12-HD	TMA-SWB-12-S6
16" Mesh Width	TMA-SWB-16-EG	TMA-SWB-16-S4
	TMA-SWB-16-HD	TMA-SWB-16-S6
18" Mesh Width	TMA-SWB-18-EG	TMA-SWB-18-S4
	TMA-SWB-18-HD	TMA-SWB-18-S6
20" Mesh Width	TMA-SWB-20-EG	TMA-SWB-20-S4
	TMA-SWB-20-HD	TMA-SWB-20-S6
24" Mesh Width	TMA-SWB-24-EG	TMA-SWB-24-S4
	TMA-SWB-24-HD	TMA-SWB-24-S6

TMA-SRC

Strut Retention Clip

Sold in Bags of 20

Type: Clamp & Guide
TM Height: 2", 4", 6"
TM Width: 4"-36"
Hardware: N/A
Includes: 20 pieces

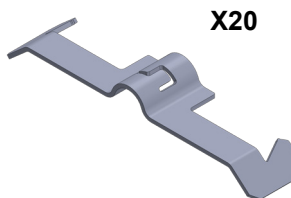

TMA-SRC-EG	N/A
N/A	N/A

TMA-FCLP

Floor Clip

Sold in Bags of 20

Type: Support
TM Height: 2", 4", 6"
TM Width: 2"-36"
Hardware: 1/4" (not incl.)
Includes: 20 pieces



TMA-FCLP-EG	TMA-FCLP-S4
TMA-FCLP-HD	TMA-FCLP-S6

Supports & Brackets



ElectroGalvanized



Painted



HotDipGalvanized



304 Stainless



TOUGHGalv

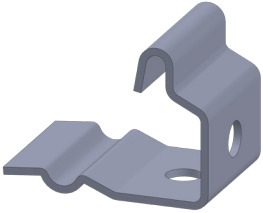

316 Stainless

TMA-AMC	
Accessory Mounting Clip	
<small>Sold in Bags of 10</small>	
<p>Type: Support TM Height: 2", 4", 6" Width: 2"-36" Hardware: 1/4" (not incl.) Includes: 10 pieces</p>	
	
TMA-AMC-EG	TMA-AMC-S4
TMA-AMC-HD	TMA-AMC-S6

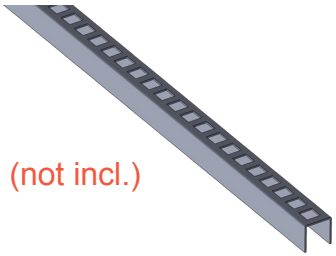
TMA-VWS	
Vertical Wall Standard	
<small>Sold Individually</small>	
<p>Type: Support TM Height: 2", 4", 6" TM Width: 2"-36" Hardware: TMA-VWSB (not incl.) Includes: 1 10' piece</p>	
	
TMA-VWS-EG	TMA-VWS-S4
TMA-VWS-HD	TMA-VWS-S6

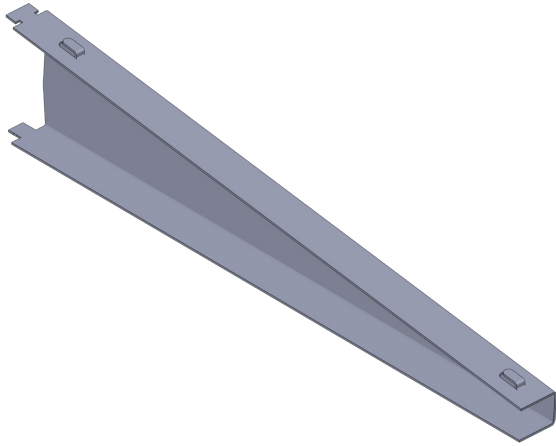
TMA-VWSB			
Vertical Wall Support Bracket			
<small>Sold Individually</small>			
	6" <small>Mesh Width</small>	TMA-VWSB-06-EG	TMA-VWSB-06-S4
		TMA-VWSB-06-HD	TMA-VWSB-06-S6
	8" <small>Mesh Width</small>	TMA-VWSB-08-EG	TMA-VWSB-08-S4
		TMA-VWSB-08-HD	TMA-VWSB-08-S6
	10" <small>Mesh Width</small>	TMA-VWSB-10-EG	TMA-VWSB-10-S4
		TMA-VWSB-10-HD	TMA-VWSB-10-S6
	12" <small>Mesh Width</small>	TMA-VWSB-12-EG	TMA-VWSB-12-S4
		TMA-VWSB-12-HD	TMA-VWSB-12-S6
	16" <small>Mesh Width</small>	TMA-VWSB-16-EG	TMA-VWSB-16-S4
		TMA-VWSB-16-HD	TMA-VWSB-16-S6
18" <small>Mesh Width</small>	TMA-VWSB-18-EG	TMA-VWSB-18-S4	
	TMA-VWSB-18-HD	TMA-VWSB-18-S6	
20" <small>Mesh Width</small>	TMA-VWSB-20-EG	TMA-VWSB-20-S4	
	TMA-VWSB-20-HD	TMA-VWSB-20-S6	
24" <small>Mesh Width</small>	TMA-VWSB-24-EG	TMA-VWSB-24-S4	
	TMA-VWSB-24-HD	TMA-VWSB-24-S6	
<p>Type: Support TM Height: 2", 4", 6" TM Width: 2"-24" Hardware: N/A Includes: 1 piece Ref: VWS (Pg. 21) * Contact CTI for alternative sizes</p>			

Supports & Barriers



ElectroGalvanized



Painted



HotDipGalvanized



304 Stainless



TOUGHGalv



316 Stainless

TMA-FFS

Fixed Floor Stand

Sold Individually

Type: Support
TM Height: 2", 4", 6"
TM Width: 4"-12"
Hardware: 1/4" (not incl.)
Includes: 1 pieces

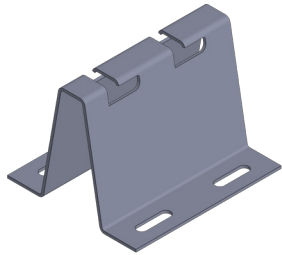

TMA-FFS-EG

N/A

TMA-FFS-HD

N/A

TMA-ADJS

Adjustable Floor Stand

Sold in Pairs

Type: Support
TM Height: 2", 4", 6"
TM Width: 4"-36"
Hardware: HDKIT (not incl.)
Includes: 2 pieces

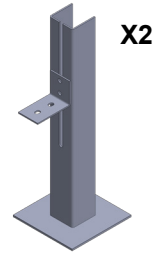

TMA-ADJS-EG

N/A

TMA-ADJS-HD

N/A

TMA-HDCB

Heavy Duty Ceiling Bracket

Sold Individually

Type: Support
TM Height: 2", 4", 6"
TM Width: 2"-36"
Hardware: 3/8" (not incl.)
Includes: 1 piece

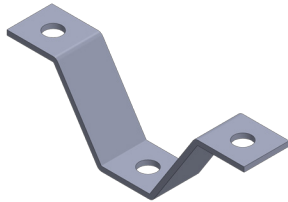

TMA-HDCB-EG

N/A

N/A

N/A

TMA-CBRG

Cable Bridge

Sold Individually

Type: Barrier
TM Height: 2", 4", 6"
TM Width: 6"-36"
Hardware: HDKIT (not incl.)
Includes: 1 pieces

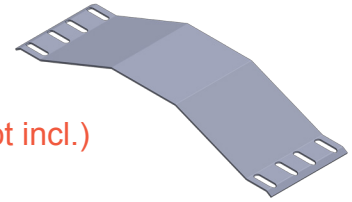

TMA-CBRG-EG

N/A

TMA-CBRG-HD

N/A

TMA-CBAR

Cable Barrier

Sold as KIT

Type: Barrier
TM Height: 2", 4", 6"
TM Width: 4"-36"
Hardware: HDKIT
Includes: 4 pieces (1kit)

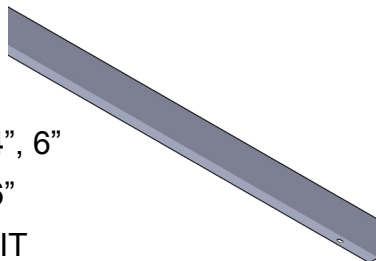

2"
Tall

TMA-CBAR-2-EG

TMA-CBAR-2-S4

TMA-CBAR-2-HD

TMA-CBAR-2-S6

4"
Tall

TMA-CBAR-4-EG

TMA-CBAR-4-S4

TMA-CBAR-4-HD

TMA-CBAR-4-S6

6"
Tall

TMA-CBAR-6-EG

TMA-CBAR-6-S4

TMA-CBAR-6-HD

TMA-CBAR-6-S6

Hooks & Adapters



ElectroGalvanized



Painted



HotDipGalvanized



304 Stainless



TOUGHGalv



316 Stainless

TMA-FSP

Fixture Support Plate

Sold in Bags of 10

Type: Adapter

TM Height: 2", 4", 6"

TM Width: 2"-36"

Hardware: HDKIT (not incl.)

Includes: 10 pieces

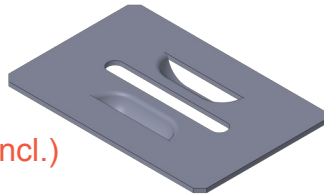

TMA-FSP-EG

N/A

TMA-FSP-S4

TMA-FSP-S6

TMA-BXCN

Box Connector

Sold in Bags of 10

Type: Adapter

TM Height: 2", 4", 6"

TM Width: 2"-36"

Hardware: N/A

Includes: 10 pieces

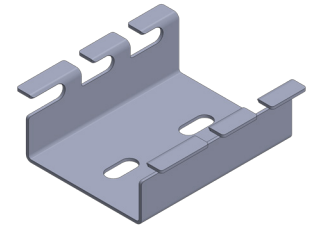

TMA-BXCN-EG

TMA-BXCN-HD

TMA-BXCN-S4

TMA-BXCN-S6

TMA-JHOOK

J-Hook

Sold Individually

Type: J-Hook

Height: 6"

Width: 1 5/8"

Hardware: 1/4" (not incl.)

Includes: 1 piece

Ref: TMA-BXN (Pg. 23)

Ref: TMA-AMC (Pg. 21)

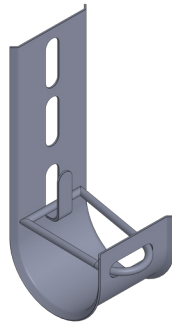

1.5"
Throat

TMA-JHOOK-150-EG

TMA-JHOOK-150-HD

N/A

N/A

2.0"
Throat

TMA-JHOOK-200-EG

TMA-JHOOK-200-HD

N/A

N/A

4.0"
Throat

TMA-JHOOK-400-EG

TMA-JHOOK-400-HD

N/A

N/A

TMA-GRND

Grounding Bolt

Sold in Bags of 10

Type: Grounding

TM Height: 2", 4", 6"

TM Width: 2"-36"

Hardware: N/A

Includes: 10 pieces



TMA-GRND

TMA-GRND

TMA-GRND

TMA-GRND

TMA-CBLD

Cable Drop

Sold Individually

Type: Drop Out

TM Height: 2", 4", 6"

TM Width: 4"-36"

Hardware: N/A

Includes: 1 piece

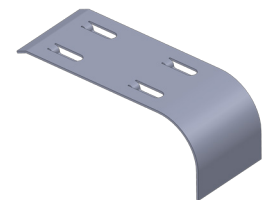

TMA-CBLD-EG

TMA-CBLD-HD

TMA-CBLD-S4

TMA-CBLD-S6



Rev:D

1725 Hughes Landing Blvd, The Woodlands, TX 77380

CT INNOVATIONS

WWW.TOUGHINNOVATIONS.COM